

To: Mitac

This specification is only used for discussing the included items.
You haven't to approve this specification.
When we shall agree the specification, we will issue the formal one.

SPECIFICATION(TENTATIVE)

FOR

TFT-LCD MODULE

LTD121EA41 T

NR-LTD121EA41 T-11

DATE OF ISSUE: 2005-02-01

TV/PC/Monitor-Use Marketing & Engineering Dept.
AVC-USE LCD Div.

Toshiba Matsushita Display Technology Co.,Ltd
1-9-2, Hatara-cho, Fukaya-shi, Saitama, 366-8510, JAPAN

Revision History

Date	Rev No	Sheet (New)	Item	Old	New	Reason

Caution and Handling Precaution

For your end user's safety, it is strongly advised that the items with "*" should be included in the instruction manual of the system which may be issued by your organization.

For Safety



Warning

- (1) Toshiba Matsushita Display Technology's Standard LCD modules have not been customized for operation in extreme environments or for use in applications where performance failures could be life-threatening or otherwise catastrophic. Since they must never be installed in aircraft navigation control systems (such as, but not limited to Traffic Collision System and Air traffic Indicator), in military defense or weapons systems, in critical industrial process-control systems (e.g., those involved in the production of nuclear energy), or in critical medical device or patient life-support systems.
- (2) DISCONNECT POWER SUPPLY before handling LCD module.
DO NOT TOUCH the parts inside LCD module and the fluorescent lamp's (hereinafter called "FL") connector or cable in order to prevent electric shock, because high voltage is supplied to these parts from the inverter unit while power supply is turned on.
- (3) Make sure to insert the module FL connector to the inverter connector in correct position.
Do not insert in irregular position.
If incorrect, this may cause smoke or burn of electrical parts by high voltage of FL circuit.
If there is a possibility that the connector has been inserted incorrectly, please re-insert the connector only after you confirm the module and FL power is completely off. When disconnecting connector, do not pull on the cable.
DO NOT USE the mating FL connector which Toshiba Matsushita Display Technology does not specify.
Otherwise, Toshiba Matsushita Display Technology shall not be liable for any damages caused by the connector.



Caution

- (1) DO NOT DISASSEMBLE OR MODIFY the module.
Sensitive parts inside LCD module may be damaged, and dusts or scratches may mar the displays.
Toshiba Matsushita Display Technology does not warrant the modules, if customer disassembled or modified them.
- * (2) DO NOT INGEST liquid crystal material, DO NOT INHALE this material, and DO NOT PERMIT this material to contact the skin, if glass of LCD panel is broken.
If liquid crystal material contacts the skin, mouth or clothing, take the following actions immediately.
In case contact to the eye or mouth, rinse with large amount of running water for more than 15 minutes. In case contact to the skin or clothing, wipe it off immediately and wash with soap and large amount of running water for more than 15 minutes. The skin or clothing may be damaged if liquid crystal material is left adhered.
In case ingestion, rinse out the mouth well with water. After spewing up by drinking large amount of water, get medical treatment.
- * (3) BE CAREFUL WITH CHIPS OF GLASS that may cause injuring fingers or skin, when the glass is broken.
Since FL is also made of glass, when FL is built in, handle it with due caution well.
- (4) Be careful with handling the metal frame (bezel) of a module. Even though burr disposal treatment is performed, it may cause injuring. Be careful with edges of glass parts and touch panel identically. For designing the system, give special consideration that the wiring and parts do not touch those edges.
- (5) DO NOT EXCEED the absolute maximum rating values under the worst probable conditions caused by the supply voltage variation, input voltage variation, variation in parts' constants, ambient temperature, etc., otherwise LCD module may be damaged.

- (6) Don't exceed "the recommended operation conditions" in this specification. (The LCD panel should be used within "the recommended operation conditions".)

The performance and quality of the LCD panel are warranted only when the LCD panel is used within "the recommended operation conditions". Toshiba Matsushita Display Technology never warrants the performance and quality of the LCDpanel when you use the LCD panel over "the recommended operation conditions", although within "the absolute maximum rating".

To use the LCD panel over "the recommended operation conditions" may have bad influence on the characteristics and reliability of the LCD panel and may shorten the life of the LCD panel.

Therefore, when designing the whole set, not to be over "the recommended operation conditions", you should fully take care of supply voltage change, characteristic of connection parts, surge of input-and-output line , and surrounding temperature.

- (7) Suitable protection circuit should be applied for each system design.

DO NOT MODIFY the fuse used in the module. It may cause overheat and/or burning if dusts or metal particles are on the PCBs in the LCD module.

- (8) Be sure that power supply output from the system should be limited to smaller values than listed shown below. (For example Quick Arcing Fuse with listed ratings can be used.)

It is because this LCD module explained in this specification has a current limiter, with such function at power input line(s). But it may be some possibility of overheat and/or burning of LCD module and its peripheral devices before current limiter of the module when open-short test of the module is performed by using power supply higher than following recommended value.

Power supply	Recommended maximum output current of power supply	Recommended Fuse Rating (in case of using fuse for current limiter)	Built-in Fuse Rating (for reference)
V _{DD}	4.0 A	0.5-3.0 A	1.25 A

- (9) Always comply with all applicable environmental regulations, when disposing of LCD.
- (10) When FL becomes extremely dark and its color changes from white to pink, stop the use of the module immediately. FL, at the end of its life with its discharge color turns into pink as the characteristics of FL, may adversely affect the module at the end part of FL due to temperature raising caused by depletion of the mercury which is contained in FL tube, or may have a possibility of breakage.

For Designing the System

- (1) Toshiba Matsushita Display Technology always endeavor to maintain sufficient quality of the LCD panel in process of designing and manufacturing, however, to avoid causing extended damages such as accidents resulting in injury or death, fire accidents, or social damages if the LCD panel fails, please adopt safe design as a whole set, by adopting redundant design , taking measure in set design to prevent fire-spreading, over-current, or incorrect operation, etc.
- (2) LCD module should be assembled to the system by using all mounting holes specified in this specification and with the specified screws. In addition, some modules may not be necessary to use all the mounting holes. Make comprehensive judgments on the entire system.

- (3) Power supply lines should be designed as follows.
 Power supplies should always be turned on before the input signals are supplied to LCD module, and the input signals should be disconnected before power supplies are turned off.
 If the sequence does not satisfy specified conditions, it may cause miss-operation of the panel.
 Refer to "2.4.2 Sequence of Power Supplies and Signals" for the detailed specification.
 In addition, refer to individual specifications for unused terminals.
- (4) DO NOT GIVE high voltage to "Low Voltage" side of the FL.
 For example, DO NOT USE a floating inverter which gives high voltage to "Low Voltage" side. it may cause insufficient brightness or unstable operation of FL, and smoke or burn of the parts.
- (5) Make sure to connect correctly high-voltage wire and low-voltage wire between FL tube and inverter unit.
- (6) Input FL starting voltage (V_{SFL}) should not be less than two second.
 If it were less than two second, it may cause unstable operation of FL.
 Inverter should be design to stop output when the inverter is no-load to FL tubes (due to breakage of FL, etc.) to prevent high-voltage generation.
 When high voltage is applied to FL continuously without normal operation of FL (due to output leakage within FL wiring circuit, etc.) it may cause smoke or burn. To prevent excess current, design the inverter with a protection circuit such as a current limiter (excess current detection) to stop inverter output.
 Please adjust inverter circuit parameters, such as capacitor, resistor, to assure the display quality is maintained.
 There is a possibility that flicker is observed by the interference of LCD operating signal timing and FL driving condition (especially driving frequency).
- (7) In case of severe environmental condition like outdoor usage, a proper transparent protective cover(lens) over LCD module is recommended to apply in order to prevent scratches, and invasion of dust, water, etc., from the system's window onto LCD module.
 Ultra-violet ray cut filter is recommended to apply onto LCD module for outdoor operation. Strong ultra-violet ray may cause damage the panel. However, in that case, transmittance-luminance will decrease. Careful selection of material is required.
- (8) Design the system not to display same pattern for a long time in order to prevent image sticking on the panel. Note that incorrect sequence of power supplies and input signals may cause the sticking on the panel, too.
- (9) Some plastic materials and shock absorbing materials (rubber) used in the system may generate gases that may cause the deterioration of the polarizer laminated on LCD's panel or internal parts of the module. Prior confirmation is required.
- (10) Some materials used for packaging (for which sulfuric acid is used in the recycling process) generate gases that may cause the deterioration of the polarizer laminated on LCD's panel or internal parts of the module. Prior confirmation is required.

For Installation in Assembly

- (1) The C-MOS LSIs used in LCD module are very sensitive to ESD (Electro-static Discharge).
 Ambient humidity of working area is recommended to be higher than 50%(RH).
 Person handling LCD modules should be grounded with wrist band. Tools like soldering iron and screw driver, and working benches should be grounded.
 The grounding should be done through a resistor of 0.5-1M Ω in order to prevent spark of ESD.
- (2) When remove protection film from LCD panel, peer off the film slowly (more than three seconds) from the edge of the panel, using a soft-pointed tweezers covered by Teflon or adherent tape.

- (3) Reduce dust level in working area. Especially the level of metal particle should be decreased.
Use finger stalls or soft and dust-free gloves in order to keep clean appearance of LCD module when handled for incoming inspection and assembly.
- * (4) When LCD panel becomes dirty, wipe off the panel surface softly with absorbent cotton or another soft cloth.
If necessary, breathe upon the panel surface and then wipe off immediately and softly again.
If the dirt can not be wiped off, absorbent cotton wetted a little with normal-hexane or petroleum benzine can be used for wiping the panel.
Be careful not to spill this solvent into the inside of LCD module. Driver ICs and PCB area used inside LCD module may be damaged by the solvent.
- * (5) AVOID THE CONDENSATION OF WATER
Wipe off a spot or spots of water of mist and chemicals of mist on LCD panel softly with absorbent cotton or another cloth as soon as possible if happened, otherwise discoloration or stain may be caused. If water invade into LCD module, it may cause LCD module damages.
- * (6) Do not expose LCD module to the gas (which is not normally contained in the atmosphere), it may cause mis-operation or defects.
- * (7) DO NOT APPLY MECHANICAL FORCES.
Do not bend or twist LCD module even momentary when LCD module is installed an enclosure of the system. Bending or twisting LCD module may cause its damages.
Make sure to design the enclosure that bending/twisting forces are not applied to LCD module when it is installed in the system.
Refrain from strong mechanical shock like dropping from the working bench or knocking against hard object.
These may cause glass of the panel crack, damage of FL or other miss-operation.
- * (8) Refrain from excessive force like pushing the surface of LCD panel. This may cause damage of the panel or electrical parts on PCB.
- * (9) Do not put heavy object such as tools, books, etc., and do not pile up LCD modules.
Be careful not to touch surface of the polarizer laminated to the panel with any hard and sharp object. The polarizer is so soft that it can easily scratched, even the protect film covers it.
- (10) When inserting or disconnecting the connectors to LCD module, be sure not to apply force against PCB, nor connecting cables, otherwise internal connection of PCB and TAB drivers may be damaged.
Do not fasten screws while putting cables like those for interface or FL between LCD module and the enclosure.
Make sure to insert the module FL connector to the inverter connector in correct position.
If incorrect, this may cause smoke or burn of electrical parts by high voltage of FL circuit.
- (11) Be careful not to pull the FL cables of the backlight in order to avoid mechanical damage in FL lamp and soldering area.
Be careful not to pull or not to hurt the FPC (Flexible Printed Circuit) cables.
- (12) Power supplies should always be turned off in assembling process.
Do not connect or disconnect the power cables and connectors with power applied to LCD module. This may cause damage of module circuit.
The signal should be applied after power are turned on. And the signal should be removed before power supplies are turned off. (Refer to "For Designing The System"(2).)
- * (13) In case of LCD long period operation, discoloration of light guide or optical sheet will be happened due to ultra violet and heat from CCFL. As the result, there is possibility to have out of specification for the optical characteristic as "5.2".
But this is not irregular phenomena. Moreover, CCFL also has the characteristic of color shift by long period operation.

For Transportation and Storage

- (1) Do not store LCD module in high temperature, especially in high humidity for a long time (approximately more than one month).
It is recommended to store LCD module where the temperature is in the range of 0 to 35 °C and the relative humidity is lower than 70%.
- (2) Store LCD module without exposure to direct sunlight or fluorescent lamps in order to prevent the module from strong ultra violet ray.
- * (3) Avoid condensation of water on LCD module, otherwise it may cause mis-operation or defects. Keep away LCD module from such ambient.
- (4) In case of transportation of storage after opening the original packing. LCD module are recommended to be repacked into the original packaging with the same method, especially with same kind of desiccant.

- CONTENTS -

Revision History	Sheet	1
Caution and Handling Precaution		2
1. Scope		8
2. Product Specifications		8
2.1 General Specifications			
2.2 Absolute Maximum Ratings			
2.3 Mechanical Specifications			
2.3.1 Weight			
2.3.2 Dimensional Outline			
2.4 Electrical Specifications			
2.4.1 Circuit Diagram			
2.4.2 Sequence of Power Supplies and Signals			
2.4.3 Timing Chart			
2.4.4 Timing Specifications			
2.4.5 Interface Connector			
2.4.6 Colors Combination Table			
3. Recommended Operating Conditions		19
4. Electrical Characteristics		20
4.1 Test Conditions			
4.2 Specifications			
5. Optical Characteristics		21
5.1 Test Conditions			
5.2 Optical Specifications			
6. Quality		22
6.1 Inspection AQL			
6.2 Test Conditions			
6.3 Dimensional Outline			
6.4 Appearance Test			
6.4.1 Test Conditions			
6.4.2 Specifications			
6.5 Display Quality			
6.5.1 Test Conditions			
6.5.2 Specifications			
6.6 Reliability Test			
6.6.1 Test Conditions			
6.6.2 Specifications			
6.7 Labels			
7. Lifetime		27
7.1 Module			
7.2 Lamp			
7.2.1 Test Conditions			
7.2.2 Specifications			
8. Packaging		28
8.1 Carton			
9. Warranty		29
10. Regulation		29
11. Measuring Method		29
11.1 Measuring Systems			
11.2 Measuring Methods			

1. Scope

This specification is applicable to Toshiba Matsushita Display Technology's 31cm diagonal size TFT-LCD module "LTD121EA41 T" designed for Personal Computer.

2. Product Specifications

2.1 General Specifications

Item	Specifications
Display Mode	TN color(64 gray scales, 262,144 colors) Transmissive type, Normally white
Viewing Direction	6 o'clock (in direction of maximum contrast)
Driving Method	TFT active matrix
Input Signals	LVDS interface CLK+,CLK- IN0+,IN0- IN1+,IN1- IN2+,IN2-
Active Area	245.76 (W) × 184.32 (H) (mm)
Viewing Area	247.76 (W) × 186.32 (H) (mm)
Bezel Opening	250.4 (W) × 188.9 (H) (mm)
Number of Pixels	1024 (W) × 768 (H) ¹⁾
Pixel Pitch	0.240 (W) × 0.240 (H) (mm) ¹⁾
Pixel Arrangement	RGB vertical stripes ¹⁾
Surface Treatment	Anti-glare and hard coat 2H on LCD surface
Backlight	Single cold-cathode fluorescent lamp for sidelighting
Dimensional Outline	261.0 (W) × 199.0 (H) × 5.2max. (D) (mm)

Note 1)

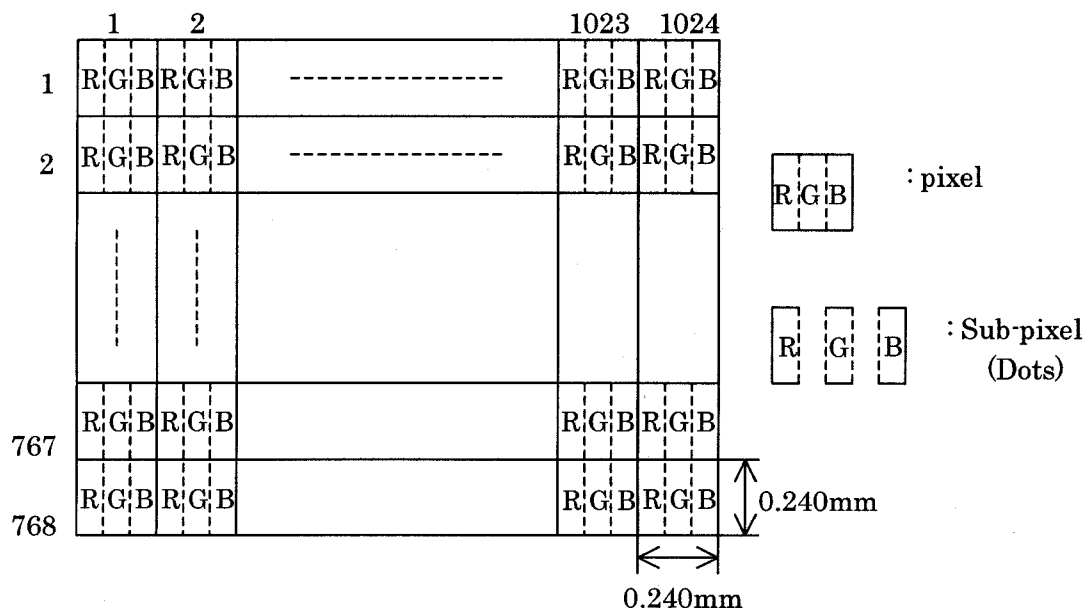

2.2 Absolute Maximum Ratings ¹⁾

Item	Symbol	Min.	Max.	Unit	Checked Terminal ⁴⁾
Supply Voltage	V_{DD}	-0.3	+4.0	V	$V_{DD} - GND$
Input Voltage of Signals	V_{IN}	-0.3	$V_{DD}+0.3$	V	LVDS interface
FL Driving Voltage	V_{FL}	-	2.0	kV(rms)	
FL Driving Frequency	f_{FL}	0	100	kHz	
Operating Ambient Temperature ²⁾	T_{OP}	0	+50	°C	
Operating Ambient Humidity ²⁾	H_{OP}	10	90	%(RH)	
Storage Temperature ²⁾	T_{STG}	-20	+60	°C	
Storage Humidity ²⁾	H_{STG}	10	90	%(RH)	
Operating Temperature for Panel ³⁾	-	0	+60	°C	

Note1) Do not exceed the maximum rating values under the worst probable conditions taking into account the supply voltage variation, input voltage variation, variation in part constants, and ambient temperature and so on. Otherwise the module may be damaged.

2) Wet bulb temperature should be 39°C Max, and no condensation of water. See figure below.

3) The surface temperature caused by self heat radiation of cell itself is specified on this item.

4) Refer to 2.4.5

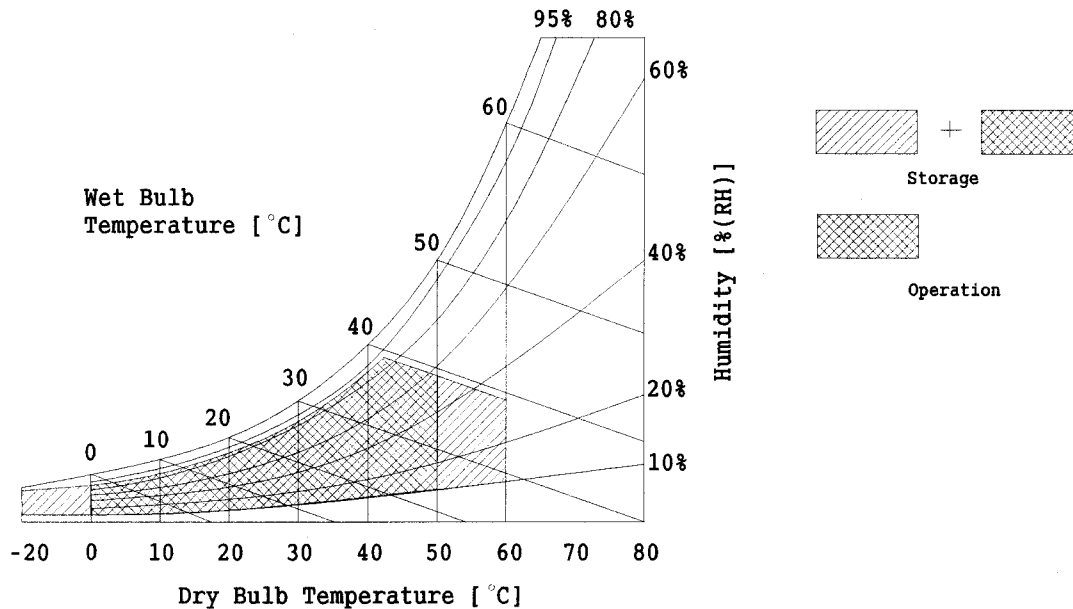

2.3 Mechanical Specifications

2.3.1 Weight

270 ± 20 (g)

2.3.2 Dimensional Outline
(front figure)

Unit : mm
Standard Tolerance: ±0.5

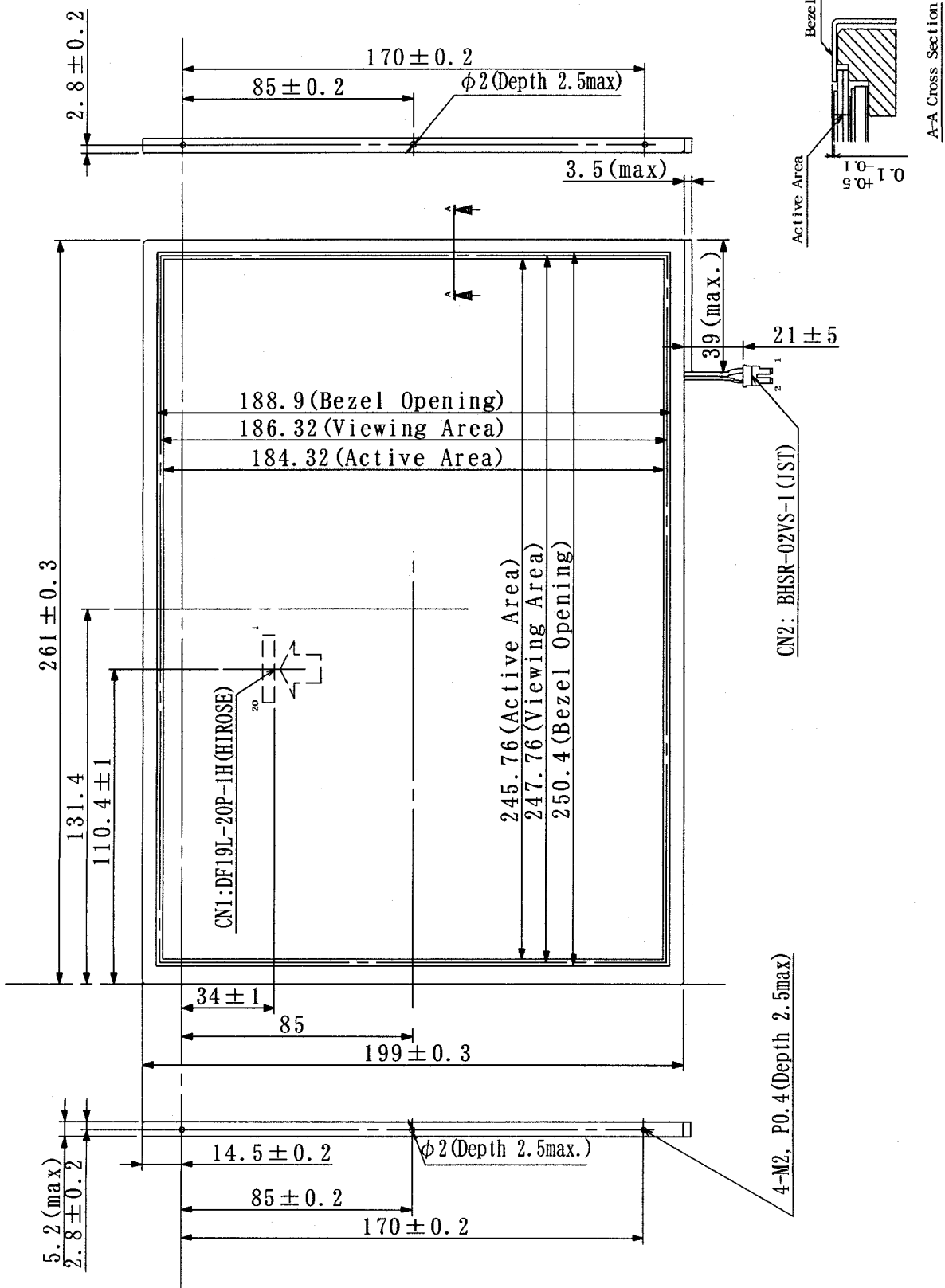

 **Warning**

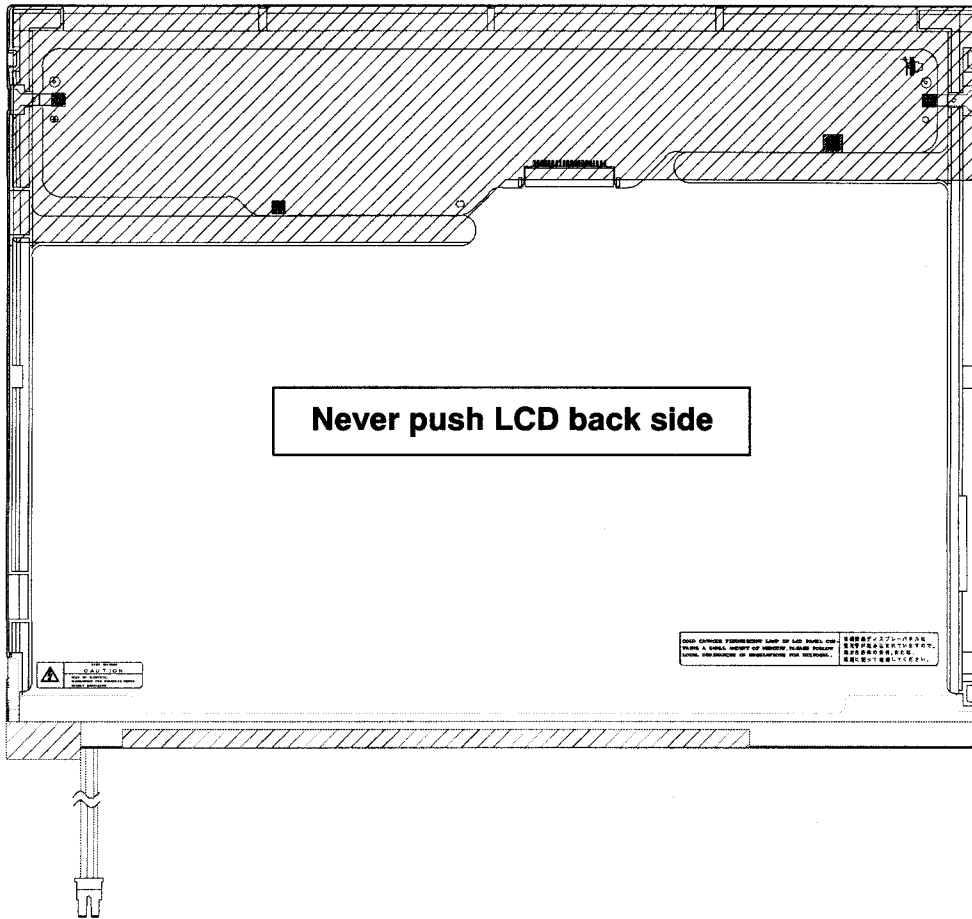

Note 1) Never push LCD back side. If LCD back side was pressed, It may cause damage of the back light system.

2.4 Electrical Specifications

2.4.1 Circuit Diagram

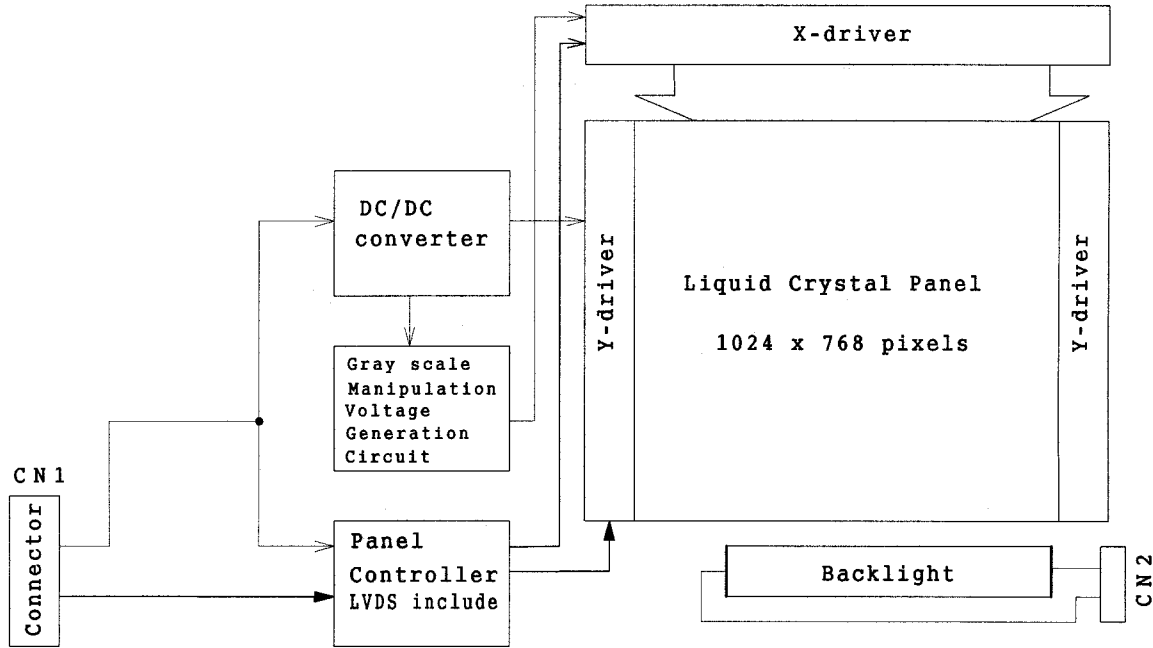

2.4.2 Sequence of Power Supplies and Signals

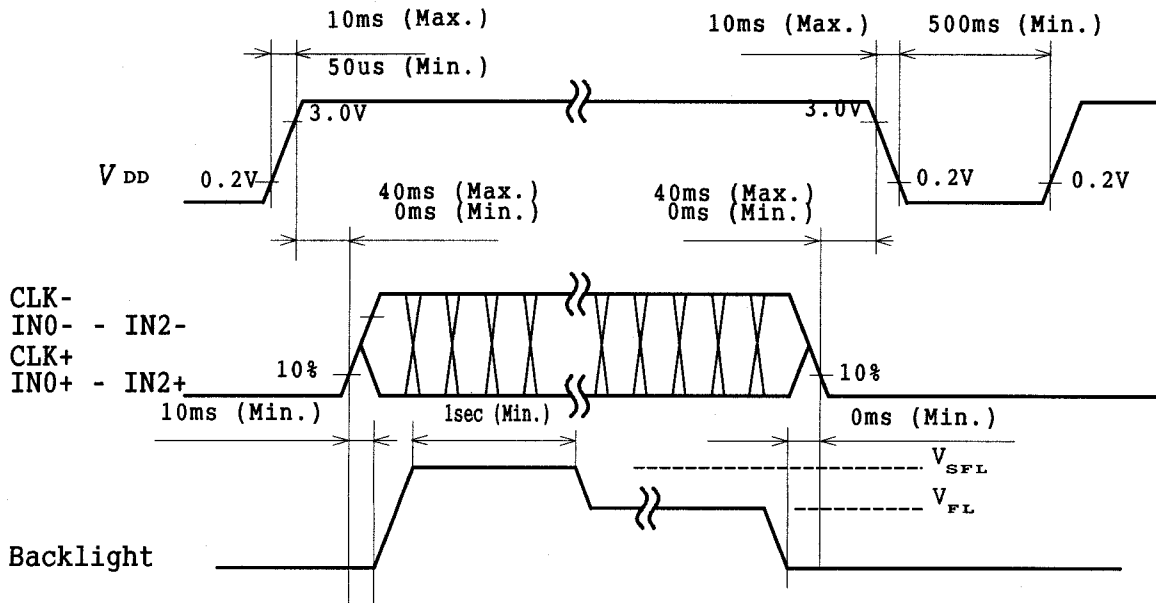

2.4.3 Timing Chart

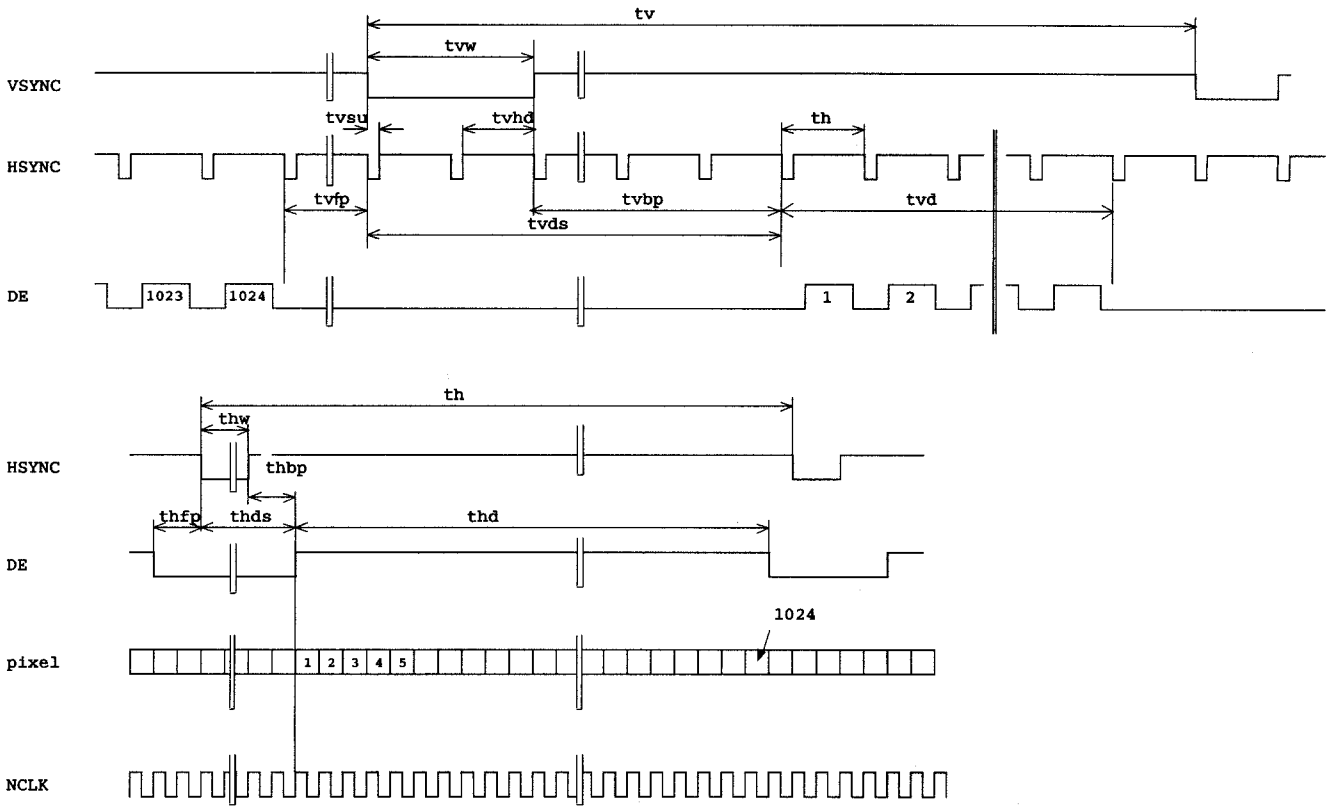

2.4.4 Timing Specifications ^{1) 2) 3) 4) 5) 6) 7)}

Item	Symbol	min.	typ.	max.	unit
Horizontal Scanning Term	f_h	$1334 \times t_c$	$1344 \times t_c$	-	clock
H-sync Pulse Width	f_{hw}	$4 \times t_c$	$136 \times t_c$	-	clock
Horizontal Front Porch	f_{hfp}	$4 \times t_c$	$24 \times t_c$	-	clock
Horizontal Back Porch	f_{hbp}	$24 \times t_c$	$160 \times t_c$	-	clock
Horizontal Data Sync Period	f_{hds}	$32 \times t_c$	$296 \times t_c$	-	clock
Horizontal Display Term	f_{hd}	$1024 \times t_c$	$1024 \times t_c$	$1024 \times t_c$	clock
Frame Period	t_v	$778 \times f_h$	$806 \times f_h$	$860 \times f_h$	line
V-sync Pulse Width	t_{vw}	$2 \times f_h$	$6 \times f_h$	-	line
V-sync Set Up Time (to H-sync)	t_{vsu}	$8 \times t_c$	-	-	clock
V-sync Hold Time	t_{vhd}	$8 \times t_c$	-	-	clock
Vertical Front Porch	t_{vfp}	$1 \times f_h$	$3 \times f_h$	-	line
Vertical Back Porch	t_{vbp}	$2 \times f_h$	$29 \times f_h$	-	line
Vertical Data Sync Period	t_{vds}	$8 \times f_h$	$35 \times f_h$	-	line
Vertical Display Term	t_{vd}	$768 \times f_h$	$768 \times f_h$	$768 \times f_h$	line
Clock Period	t_c	15.0	15.38	-	ns

Note 1) Refer to "Timing Chart" and LVDS (THC63LVDF84A-85) specifications by THine Electronics, Inc.

Note 2) If CLK is fixed to "H" or "L" level for certain period while DE is supplied, the panel may be damaged.

Note 3) Please adjust LCD operating signal timing and FL driving frequency, to optimize the display quality.

There is a possibility that flicker is observed by the interference of LCD operating signal timing and FL driving condition (especially driving frequency), even if the condition satisfies above timing specifications and recommended operating conditions shown in 3.

Note 4) Do not make t_v , f_h , f_{hbp} and t_{vds} fluctuate.

If t_v , f_h , f_{hbp} and t_{vds} are fluctuate, the panel displays black.

Note 5) In case of using the long frame period, the deterioration of display quality, noise etc. may be occurred.

Note 6) CLK count of each Horizontal Scanning Time should be always the same.

V-Blanking period should be " n " X "Horizontal Scanning Time". (n : integer)

Frame period should be always the same.

2.4.5 Interface Connector

CN1 INPUT SIGNAL (DF19L-20P-1H / HIROSE)

[Mating Connector : DF19G-20S-1C (Cable),
DF19G-20S-1F (FRC Type) / HIROSE]

Terminal No.	Symbol	Function
1	V _{DD}	Power Supply : +3.3V
2	V _{DD}	Power Supply : +3.3V
3	V _{SS}	GND
4	V _{SS}	GND
5	RxIN0-	Negative LVDS differential data input (R0-R5,G0)
6	RxIN0+	Positive LVDS differential data input (R0-R5,G0)
7	V _{SS}	GND
8	RxIN1-	Negative LVDS differential data input (G1-G5, B0-B1)
9	RxIN1+	Positive LVDS differential data input (G1-G5, B0-B1)
10	V _{SS}	GND
11	RxIN2-	Negative LVDS differential data input (B2-B5, HS, VS, DE)
12	RxIN2+	Positive LVDS differential data input (B2-B5, HS, VS, DE)
13	V _{SS}	GND
14	CLK-	Clock Signal(-)
15	CLK+	Clock Signal(+)
16	V _{SS}	GND
17	NC	
18	NC	
19	V _{SS}	GND
20	V _{SS}	GND

Note 1) Please connect GND pin to ground. Don't use it as no-connect nor connectiton with high impedance.

CN2 CCFL POWER SOURCE (BHSR-02VS-1/JAPAN SOLDERLESS TERMINAL MFG CO., LTD.)

[Mating Connector : SM02B-BHS-1/JAPAN SOLDERLESS TERMINAL MFG CO., LTD.]

Terminal No.	Symbol	Function
1	V _{FLH}	CCFL POWER SUPPLY (HIGH VOLTAGE)
2	V _{FLL}	CCFL POWER SUPPLY (LOW VOLTAGE)

Note 1) 262,144 colors are displayed by the combinations of 18 bits data. (See next page)

**RECOMMENDED TRANSMITTER TRANSMITTER (THC63LVDF83A,THC63LVDM83A,THC63LVDM83A-85)
TO LTD121EA41 T INTERFACE ASSIGNMENT**

Case1: 6Bit TRANSMITTER

Input Terminal No.		Input Signal (Graphics controller output signal)		Output Signal Symbol	To LTD121EA41 T Interface(CN1)	
Symbol	Terminal	Symbol	Function		Terminal	Symbol
TA0	44	R0	Red Pixels Display Data (LSB)	TA- TA+	No.5 No.6	RxIN0- RxIN0+
TA1	45	R1	Red Pixels Display Data			
TA2	47	R2	Red Pixels Display Data			
TA3	48	R3	Red Pixels Display Data			
TA4	1	R4	Red Pixels Display Data			
TA5	3	R5	Red Pixels Display Data (MSB)			
TA6	4	G0	Green Pixels Display Data (LSB)	TB- TB+	No.8 No.9	RxIN1- RxIN1+
TB0	6	G1	Green Pixels Display Data			
TB1	7	G2	Green Pixels Display Data			
TB2	9	G3	Green Pixels Display Data			
TB3	10	G4	Green Pixels Display Data			
TB4	12	G5	Green Pixels Display Data (MSB)			
TB5	13	B0	Blue Pixels Display Data (LSB)	TC- TC+	No.11 No.12	RxIN2- RxIN2+
TB6	15	B1	Blue Pixels Display Data			
TC0	16	B2	Blue Pixels Display Data			
TC1	18	B3	Blue Pixels Display Data			
TC2	19	B4	Blue Pixels Display Data			
TC3	20	B5	Blue Pixels Display Data (MSB)			
TC4	22	HSYNC	H-Sync	TCLK - TCLK +	No.14 No.15	CLK IN- CLK IN+
TC5	23	VSYNC	V-Sync			
TC6	25	DE	Compound Synchronization Signal			
CLK IN	26	NCLK	Data Sampling Clock			

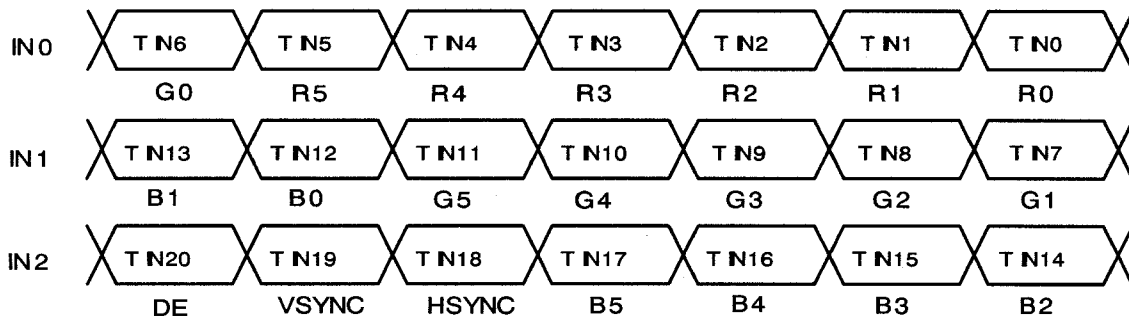

**RECOMMENDED TRANSMITTER (THC63LVDF83A,THC63LVDM83A,THC63LVDM83A-85)
TO LTD121EA41 T INTERFACE ASSIGNMENT**

Case2: 8Bit TRANSMITTER

Input Terminal No.		Input Signal (Graphics controller output signal)		Output Signal Symbol	To LTD121EA41 T Interface(CN1)	
Symbol	Terminal	Symbol	Function		Terminal	Symbol
TA0	51	R0	Red Pixels Display Data (LSB)	TA- TA+	No.5 No.6	RxIN0- RxIN0+
TA1	52	R1	Red Pixels Display Data			
TA2	54	R2	Red Pixels Display Data			
TA3	55	R3	Red Pixels Display Data			
TA4	56	R4	Red Pixels Display Data			
TA5	3	R5	Red Pixels Display Data (MSB)	TB- TB+	No.8 No.9	RxIN1- RxIN1+
TA6	4	G0	Green Pixels Display Data(LSB)			
TB0	6	G1	Green Pixels Display Data			
TB1	7	G2	Green Pixels Display Data			
TB2	11	G3	Green Pixels Display Data			
TB3	12	G4	Green Pixels Display Data	TC- TC+	No.11 No.12	RxIN2- RxIN2+
TB4	14	G5	Green Pixels Display Data(MSB)			
TB5	15	B0	Blue Pixels Display Data (LSB)			
TB6	19	B1	Blue Pixels Display Data			
TC0	20	B2	Blue Pixels Display Data			
TC1	22	B3	Blue Pixels Display Data	TD- TD+	-	-
TC2	23	B4	Blue Pixels Display Data			
TC3	24	B5	Blue Pixels Display Data (MSB)			
TC4	27	HSYNC	H-Sync			
TC5	28	VSYNC	V-Sync			
TC6	30	DE	Compound Synchronization Signal	TCLK- TCLK+	No.14 No.15	CLK- CLK+
TD0	50	NC	Non Connection (open)			
TD1	2	NC	Non Connection (open)			
TD2	8	NC	Non Connection (open)			
TD3	10	NC	Non Connection (open)			
TD4	16	NC	Non Connection (open)			
TD5	18	NC	Non Connection (open)			
TD6	25	NC	Non Connection (open)			
CLK IN	31	NCLK	Data Sampling Clock			

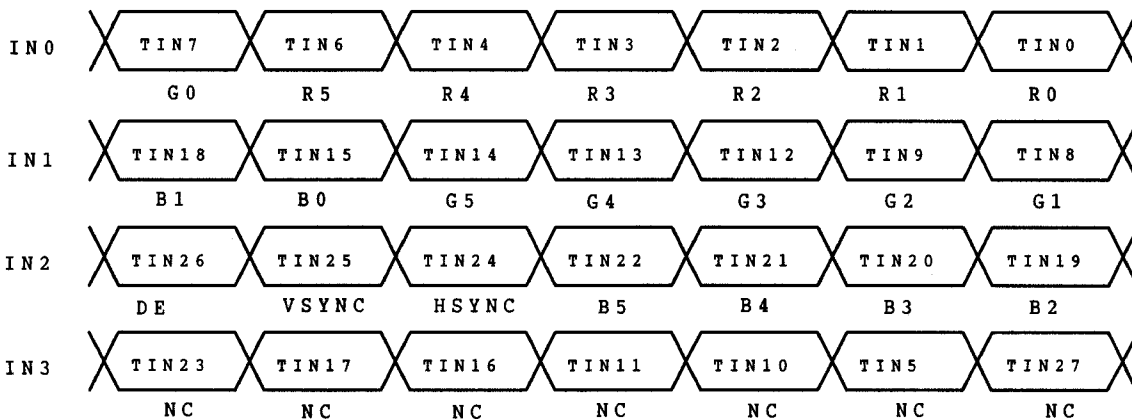

2.4.6 Colors Combination Table

	Display	R5 R4 R3 R2 R1 R0	G5 G4 G3 G2 G1 G0	B5 B4 B3 B2 B1 B0	Gray ScaleLevel
Basic Color	Black	L L L L L L	L L L L L L	L L L L L L	-
	Blue	L L L L L L	L L L L L L	H H H H H H	-
	Green	L L L L L L	H H H H H H	L L L L L L	-
	Light Blue	L L L L L L	H H H H H H	H H H H H H	-
	Red	H H H H H H	L L L L L L	L L L L L L	-
	Purple	H H H H H H	L L L L L L	H H H H H H	-
	Yellow	H H H H H H	H H H H H H	L L L L L L	-
	White	H H H H H H	H H H H H H	H H H H H H	-
Gray Scale of Red	Black	L L L L L L	L L L L L L	L L L L L L	L 0
	Dark ↑ ↓ Light	L L L L L H	L L L L L L	L L L L L L	L 1
		L L L L H L	L L L L L L	L L L L L L	L 2
		⋮	⋮	⋮	L3... L60
		H H H H L H	L L L L L L	L L L L L L	L61
	H H H H H L	L L L L L L	L L L L L L	L62	
Red	H H H H H H	L L L L L L	L L L L L L	Red L63	
Gray Scale of Green	Black	L L L L L L	L L L L L L	L L L L L L	L 0
	Dark ↑ ↓ Light	L L L L L L	L L L L L H	L L L L L L	L 1
		L L L L L L	L L L L H L	L L L L L L	L 2
		⋮	⋮	⋮	L3... L60
		L L L L L L	H H H H L H	L L L L L L	L61
	L L L L L L	H H H H H L	L L L L L L	L62	
Green	L L L L L L	H H H H H H	L L L L L L	Green L63	
Gray Scale of Blue	Black	L L L L L L	L L L L L L	L L L L L L	L 0
	Dark ↑ ↓ Light	L L L L L L	L L L L L L	L L L L L H	L 1
		L L L L L L	L L L L L L	L L L L H L	L 2
		⋮	⋮	⋮	L3... L60
		L L L L L L	L L L L L L	H H H H L H	L61
	L L L L L L	L L L L L L	H H H H H L	L62	
Blue	L L L L L L	L L L L L L	H H H H H H	Blue L63	
Gray Scale of White & Black	Black	L L L L L L	L L L L L L	L L L L L L	L 0
	Dark ↑ ↓ Light	L L L L L H	L L L L L H	L L L L L H	L 1
		L L L L H L	L L L L H L	L L L L H L	L 2
		⋮	⋮	⋮	L3... L60
		H H H H L H	H H H H L H	H H H H L H	L61
	H H H H H L	H H H H H L	H H H H H L	L62	
White	H H H H H H	H H H H H H	H H H H H H	white L63	

Note1 L: Low level voltage, H: High level voltage

3. Recommended Operating Conditions ^{1) 2) 3) 10)}

Item	Symbol	Min.	Typ.	Max.	Unit	Remarks
Supply Voltage ⁴⁾	V_{DD}	3.0	3.3	3.6	V	
Differential Input Voltage	V_{ID}	100	-	600	mV	
Comon Mode Input Voltage	V_{CM}	1.0	-	$2.4-(V_{ID})/2$	V	
FL Input Current ^{6) 7) 8)}	I_{FL}	2.0	-	6.0	mA(rms)	
FL Driving Voltage ⁶⁾	V_{FL}	570	620	670	V(rms)	$I_{FL}=6.0\text{mA(rms)}$ (Reference)
FL Driving Frequency ⁶⁾	f_{FL}	40	50	60	kHz	
FL Starting Voltage ^{6) 9)}	V_{SFL}	1400	-	1800	V(rms)	0°C

Note 1) The module should be always operated within these ranges. The "Typ." shows the recommendable value.

2) Recommended LVDS transmitter: THC63LVDF63A, THC63LVDM63A, THC63LVDM63A-85, THC63LVDF83A, THC63LVDM83A, THC63LVDM83A-85 (made by THine Electronics, Inc.)

Panel Controller contains LVDS, which is based on THC63LVDF84A-85 (made by THine Electronics, Inc.) specification.

3) Checked Pin Terminal: V_{DD} , GND (0V)

4) Checked Pin Terminal: IN0~CLK+, GND (0V)

Measure: $|V_{IN0+}-V_{IN0-}|$, $|V_{IN1+}-V_{IN1-}|$,
 $|V_{IN2+}-V_{IN2-}|$, $|V_{CLKN+}-V_{CLK-}|$

Measure: $(V_{IN0+}-V_{IN0-})/2$, $(V_{IN1+}-V_{IN1-})/2$,
 $(V_{IN2+}-V_{IN2-})/2$, $(V_{CLK+}-V_{CLK-})/2$,

5) Checked Pin Terminal: V_{FLH} - F_{FL}

6) If FL input current (I_{FL}) is higher than typical value (6.0mA(rms)), then FL lifetime becomes shorter.

7) Measuring Method of I_{FL} .

8) Input FL starting voltage (V_{SFL}) should not be less than two second.

If it were less than two second, it may cause unstable operation of FL.

9) Please adjust LCD operating signal timing and FL driving frequency, to optimize the display quality.

There is a possibility that flicker is observed by the interference of LCD operating signal timing and FL driving condition (especially driving frequency), even if the condition satisfies above recommended operating conditions and timing specifications shown in 2.4.4.

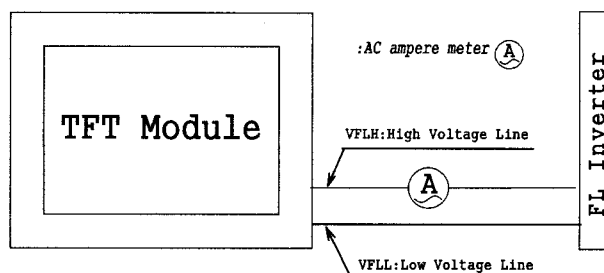

4. Electrical Characteristics

4.1 Test Conditions

Ambient Temperature	: T_a	25±5°C
Ambient Humidity	: H_a	65±20%(RH)
Supply Voltage	: V_{DD}	3.3V
Input Signal	: Refer typical value in "2.4.4 Timing Specifications".	
FL Input Current	: I_{FL}	6.0mA(rms)
FL Driving Frequency	: f_{FL}	50kHz

4.2 Specifications

Item	Symbol	Min.	Typ. ¹⁾	Max.	Unit	Remark
Current Consumption	I_{DD}	-	225	400	mA	V_{DD} Terminal Current

Note 1) The Typical value of I_{DD} is measured in the following pattern.

1. White
2. Yellow
3. Purple
4. Red
5. Light Blue
6. Green
7. Blue
6. Black

1	2	3	4	5	6	7	8
---	---	---	---	---	---	---	---

5. Optical Characteristics

5.1 Test Conditions

It is same as 4.1

The measuring method is shown in 11.

5.2 Optical Specifications ¹⁾

Item	Symbol	Conditions	Specifications			Unit	Remark	
			Min.	Typ	Max.			
Viewing Angle	θ	$CR \geq 10$	$\phi = 180^\circ$	10	-	-	°	
			$\phi = 0^\circ$	20	-	-	°	
			$\phi = 90^\circ$	30	-	-	°	
			$\phi = -90^\circ$	30	-	-	°	
Contrast Ratio	CR	$\theta = 0^\circ, \phi = 0^\circ$	150	-	-	-		
Response Time	$t_{ON} + t_{OFF}$	$\theta = 0^\circ, \phi = 0^\circ$	-	-	50	ms		
Luminance	L	$\theta = 0^\circ, \phi = 0^\circ$ Gray Scale Level=L63 (White)	160	200	-	cd/m ²	$I_{FL} = 6.0mA(rms)$	
Luminance Uniformity ²⁾	LUNF	$\theta = 0^\circ, \phi = 0^\circ$ Gray Scale Level=L63 (White)	55	-	-	%	Lmin/Lmax	
Chromaticity	Red	x_R	Gray Scale Level:L63	0.533	0.583	0.633	-	
		y_R	$\theta = 0^\circ, \phi = 0^\circ$	0.281	0.331	0.381	-	
	Green	x_G	Ditto	0.266	0.316	0.366	-	
		y_G		0.479	0.529	0.579	-	
	Blue	x_B	Ditto	0.099	0.149	0.199	-	
		y_B		0.074	0.124	0.174	-	
	White	x_W	Ditto	0.282	0.322	0.362	-	
		y_W		0.292	0.332	0.372	-	

Note 1): Refer to "11. Measuring Method".

Note 2): The above test limit must be applied for initial use. Characteristics will be shifted by long period operation, but it is not irregular phenomena. Theoretically brightness characteristics will be decreased due to CCFL degradation and color shift due to optical components change.

6. Quality

6.1 Inspection AQL

Total of Major Defects	: AQL 0.65 %
Total of Minor Defects	: AQL 1.5 %
Sampling Method	: ANSI / ASQC Z1.4 (Level II)

6.2 Test Conditions

1) Ambient Temperature	: 25±5°C
2) Ambient Humidity	: 65±20%(RH)
3) Illumination	: Approximately 500 lx under the fluorescent lamp
4) Viewing Distance	: Approximately 30cm by the eyes of the inspector from the module
5) Inspection Angle	: $\theta = 0^\circ$, $\phi = 0^\circ$

6.3 Dimensional Outline

The products shall conform to the dimensions specified in 2.3.2.

Definition of Major and Minor defects are as follows.

Item	Description	Class
Important Dimensions	Dimensional outline, Dimensional between the mounting holes(hinge)	Major
Others	Dimensions specified in this specifications	Minor

6.4 Appearance Test

6.4.1 Test Conditions

1) Condition : Non-operating, operating (Pattern : L63 white raster)

Same as 6.2

6.4.2 Specifications

Item	Description	Class												
PCB Appearance	Pattern peeling snapping, electrically short	Major												
	Repair portion on PCB is not covered by epoxy resin													
Soldering	Cold solder joint, lead move when pulled	Minor												
Bezel, Frame, Connectors	Distinct stain, rust or scratch	Major												
Black and White Spots/Lines ¹⁾²⁾	<table border="1"> <thead> <tr> <th>Line width</th> <th>Length(mm)</th> <th>Acceptable count</th> </tr> </thead> <tbody> <tr> <td>$W \leq 0.05$</td> <td rowspan="4" style="text-align: center;">$L \leq 3$</td> <td>neglect</td> </tr> <tr> <td>$0.05 < W \leq 0.07$</td> <td>$n \leq 8$</td> </tr> <tr> <td>$0.07 < W \leq 0.10$</td> <td>$n \leq 2$</td> </tr> <tr> <td>$0.10 < W$</td> <td>²⁾</td> </tr> </tbody> </table>	Line width	Length(mm)	Acceptable count	$W \leq 0.05$	$L \leq 3$	neglect	$0.05 < W \leq 0.07$	$n \leq 8$	$0.07 < W \leq 0.10$	$n \leq 2$	$0.10 < W$	²⁾	Minor
	Line width	Length(mm)	Acceptable count											
	$W \leq 0.05$	$L \leq 3$	neglect											
	$0.05 < W \leq 0.07$		$n \leq 8$											
	$0.07 < W \leq 0.10$		$n \leq 2$											
	$0.10 < W$		²⁾											
	<table border="1"> <thead> <tr> <th>Average diameter(mm)</th> <th>Acceptable count/side</th> </tr> </thead> <tbody> <tr> <td>$D \leq 0.2$</td> <td>neglect</td> </tr> <tr> <td>$0.2 < D \leq 0.3$</td> <td>$n \leq 5$</td> </tr> <tr> <td>$0.3 < D \leq 0.5$</td> <td>$n \leq 2$</td> </tr> <tr> <td>$0.5 < D$</td> <td>0</td> </tr> </tbody> </table>	Average diameter(mm)	Acceptable count/side	$D \leq 0.2$	neglect	$0.2 < D \leq 0.3$	$n \leq 5$	$0.3 < D \leq 0.5$	$n \leq 2$	$0.5 < D$	0			
	Average diameter(mm)	Acceptable count/side												
	$D \leq 0.2$	neglect												
	$0.2 < D \leq 0.3$	$n \leq 5$												
$0.3 < D \leq 0.5$	$n \leq 2$													
$0.5 < D$	0													

Note 1) Inspection area should be within viewing area.

Note 2) Black/White Spot, Polarizer Dents and Polarizer Bubble shall be judged by "Average Diameter".

Average Diameter $D = (a+b) / 2$ (mm)

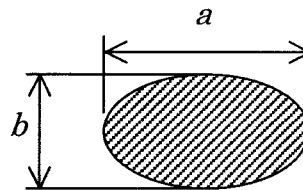

6.5 Display Quality

6.5.1 Test Conditions

- 1) Inspection Area : Within active area
 2) Driving Condition : Same as test conditions shown in 4.1 and 6.2
 3) Test Pattern : White display pattern (gray scale level L63) and black display pattern (gray scale level L0)

6.5.2 Specifications ⁴⁾

Item	Description / Specifications	Class																				
Function	No display, Malfunction	Major																				
Display Quality ¹⁾	Missing line	Major																				
	Missing Sub-Pixels	Major																				
	<table border="1"> <tbody> <tr> <td>1) Bright defects²⁾³⁾</td> <td>5pcs. max.</td> </tr> <tr> <td>2) Dark defects²⁾</td> <td>5pcs. max.</td> </tr> <tr> <td>3) Total sub-pixel defects</td> <td>8pcs. max.</td> </tr> <tr> <td>4) 2 Conjunction Bright defects</td> <td>2 set max.</td> </tr> <tr> <td>5) 3 Conjunction Bright defects</td> <td>0 set max.</td> </tr> <tr> <td>6) 2 Conjunction Dark defects</td> <td>2 set max.</td> </tr> <tr> <td>7) 3 Conjunction Dark defects</td> <td>0 set max.</td> </tr> <tr> <td>8) Bright defect to Bright defect distance</td> <td>15mm min</td> </tr> <tr> <td>9) Dark defect to dark defect distance</td> <td>5mm min.</td> </tr> <tr> <td>10) Other Item</td> <td>Neglect</td> </tr> </tbody> </table>	1) Bright defects ²⁾³⁾	5pcs. max.	2) Dark defects ²⁾	5pcs. max.	3) Total sub-pixel defects	8pcs. max.	4) 2 Conjunction Bright defects	2 set max.	5) 3 Conjunction Bright defects	0 set max.	6) 2 Conjunction Dark defects	2 set max.	7) 3 Conjunction Dark defects	0 set max.	8) Bright defect to Bright defect distance	15mm min	9) Dark defect to dark defect distance	5mm min.	10) Other Item	Neglect	
1) Bright defects ²⁾³⁾	5pcs. max.																					
2) Dark defects ²⁾	5pcs. max.																					
3) Total sub-pixel defects	8pcs. max.																					
4) 2 Conjunction Bright defects	2 set max.																					
5) 3 Conjunction Bright defects	0 set max.																					
6) 2 Conjunction Dark defects	2 set max.																					
7) 3 Conjunction Dark defects	0 set max.																					
8) Bright defect to Bright defect distance	15mm min																					
9) Dark defect to dark defect distance	5mm min.																					
10) Other Item	Neglect																					
	Inconspicuous flicker, crosstalk, Newton's ring, Mottling Rubbing defect, Dim Lines, Horizontal Line and Vertical Line. : neglect	-																				
Black and White Spots/lines	Inconspicuous defects : neglect	-																				
Backlight	Missing (Non-operating)	Major																				

Note 1) Defects of both color filter and black matrix are counted as bright or dark defects.

Inspection area should be within the active area.

Note 2) Bright defect means a bright spot(sub-pixel) on the display pattern of gray scale L0.

Dark defect means a dark spot(sub-pixel) on the display pattern of gray scale L63.

Note 3) Bright spot which can not be found by using 5%ND-Filter shall not be counted as a defect.

6.6 Reliability Test

6.6.1 Test Conditions

- 1) The module should be driven and inspected under normal test conditions.
- 2) The module should not have condensation of water (moisture) on the module.
- 3) The module should be inspected after two or more hours storage in normal conditions (15 - 35°C, 45 - 65%(RH)).
- 4) A module shall be used only for one test.

6.6.2 Specifications

The module shall have no failure in the following reliability test items.

Test Item	Test Conditions	Result
High Temperature Operation ¹⁾	50°C 192 h	OK 3p/3p
High Temperature Storage ²⁾	60°C 192 h	OK 3p/3p
High Temperature and High Humidity operation ¹⁾	50°C 80% 192 h	OK 3p/3p
Low Temperature Operation ¹⁾	0°C 192 h	OK 3p/3p
Low Temperature Storage ²⁾	-20°C 192 h	OK 3p/3p
Temperature Shock ²⁾	-20°C ⇔ 60°C 0.5h 0.5h 50 cycles	OK 3p/3p
Mechanical Vibration ²⁾	10 – 200 - 10Hz sweep/cycle, 1.5×9.8m/s ² constant, X.Y.Z each direction, 0.5h each	OK 3p/3p
Mechanical Shock ²⁾	50×9.8m/s ² , 20ms, ±X, ±Y, ±Z each direction, one time each	OK 3p/3p

Note 1) Operating

Note 2) Non-Operating

Definitions of failure for judgment shall be as follows:

- 1) Function of the module should be maintained.
- 2) Current consumption should be smaller than the specified value.
- 3) Appearance and display quality should not have distinguished degradation.
- 4) Luminance should be larger than 50% of the minimum value specified in 5.2.

6.7 Labels

(1) Product Label

Serial number : △△ ▲ 4A 000001

① ② ③ ④

① : Module type code

② : Manufacturing code

③ : Lot code 4 A

(1) (2)

(1):Year code-end of the A.D.

(2):Month code-alphabet → Jan. : A - Dec. : L

Bar code : CODE-39 High-density

(Example : 4A → 2004 JAN.)

④ : Serial code

decimal, 6 figures



(2) Caution Labels

• High Voltage

• Disposal of CCFL

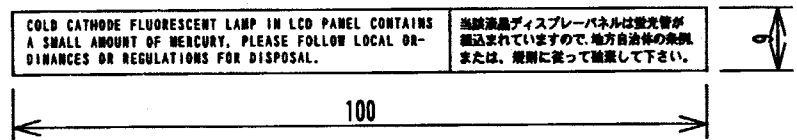
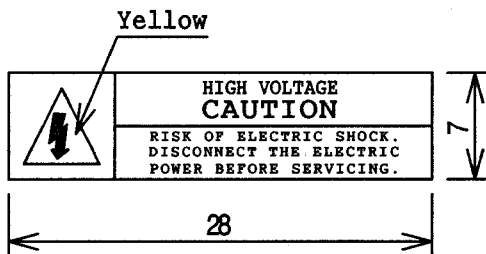

Unit: mm

3) Label Locations

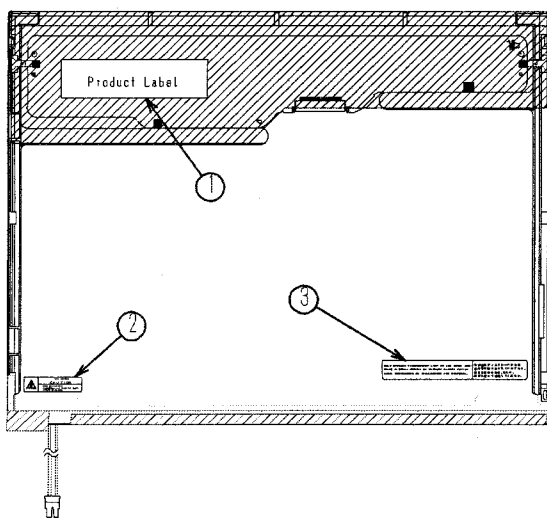

①:Product Label

②:Caution Label

③:Disposal of CCFL

7. Lifetime

7.1 Module (except lamp)

MTTF (Mean Time To Failure) : 50,000 h

(This value is not assurance time but inference value by following conditions.)

Conditions : Ambient temperature : 25±5°C (No wind)

Ambient humidity : 65%(RH)

7.2 Lamp

7.2.1 Test Conditions

Ambient temperature : 25±5°C (No wind)

Lamp current : 6.0mA(rms)

Lighting condition : continuous lighting

Driving frequency : 50kHz

7.2.2 Specifications

MTBF : 10,000 h

Definitions of failure for judgment shall be as follows.

- 1) LCD luminance becomes half of the minimum value specified in 5.2.
- 2) Lamp doesn't light normally.

(Note1) In case of LCD long period operation, discoloration of light guide or optical sheet will be happened due to ultra violet and heat from CCFL. As the result, there is possibility to have out of specification for the optical characteristics as "4.3.2". But this is not irregular phenomena. Moreover, CCFL also has the characteristic of color shift by long period operation.

8. Packaging

8.1 Carton (internal package)

(1) Packaging Form

Corrugated cardboard box and polyethylene foam as shock absorber

(2) Packaging Method ¹⁾²⁾

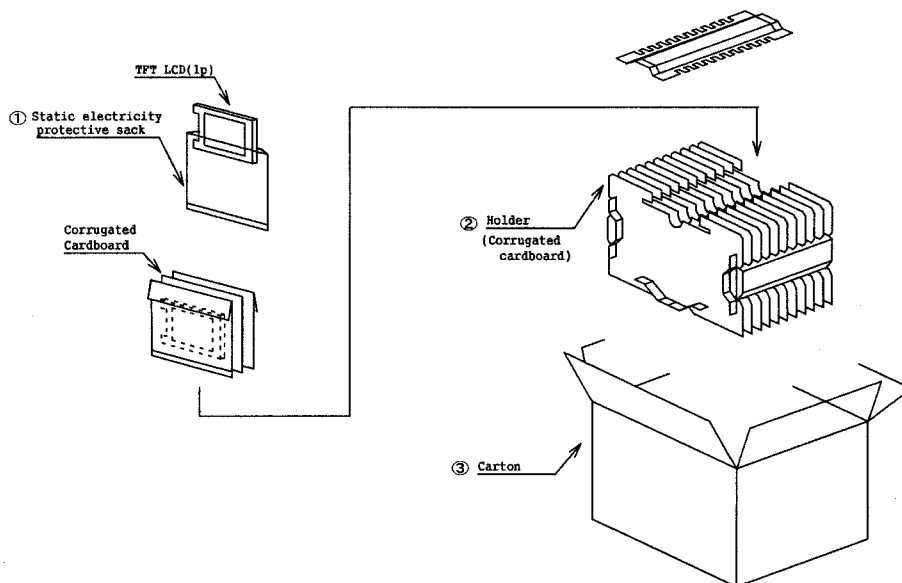

Note 1): Total weight : (Approx.) 12 kg

Note 2): Acceptable number of palette piling: 2 sets

(3) Packaging Material

Number	Quantity	Description
①	25p	Static electricity Protective sack
②	1set	Holder
③	1p	Corrugated card box
④	-	Plastics adhesive tape

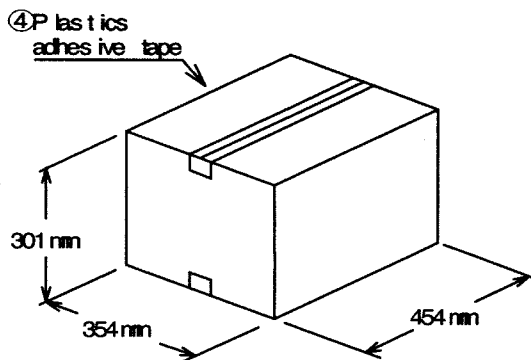

(4) Carton Marking

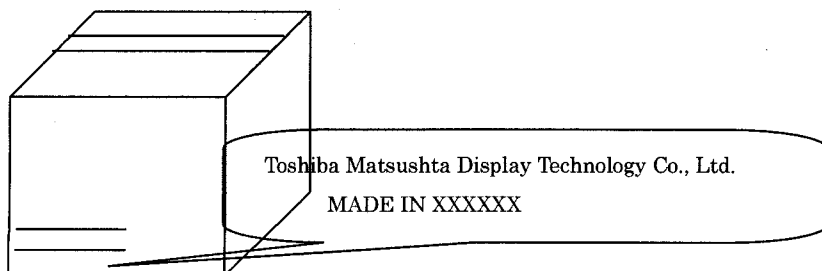

9. Warranty

Warranty clause will be decided separately.

10. Regulation

The set (which our LCD module is assembled into) to conform the regulations below, take measures in set side. Toshiba Matsushita Display Technology is not liable for the regulations to the complete set, nor can guarantee our LCD module conform the regulation by itself.

a) Examples of EMI Regulations

FCC : PART15 CLASS B
 VCCI : CLASS B
 CISPR : CLASS B

b) Examples of Safety Regulations

IEC 60950
 UL 60950

11. Measuring Method

11.1 Measuring System

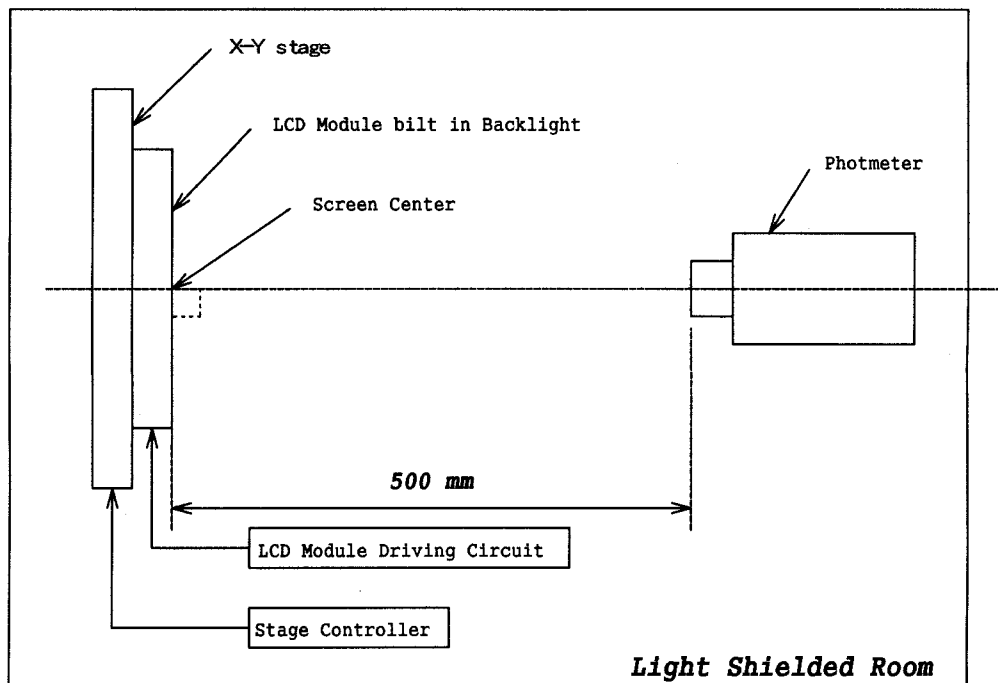

(1) The measurement point is the center of the active area except for the measurement of Luminance Uniformity.

(2) Photometer : BM-5A / BM-7 TOPCON (Aperture 2°)

(3) Definition of ϕ and θ :

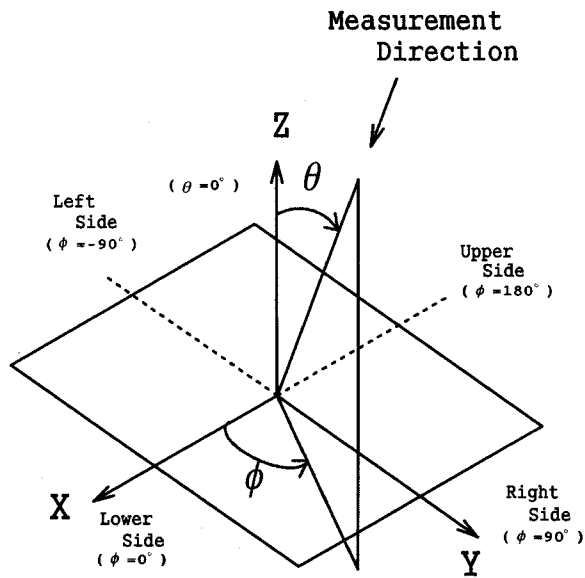

11.2 Measuring Methods

(1) Luminance:

The luminance of the center on a white raster (gray scale level L63) shall be measured.
Measurement shall be executed 30 minutes after the lamp is lit up.

(2) Contrast Ratio:

The contrast ratio can be calculated by the following expression.

$$\text{Contrast Ratio (CR)} = L63 / L0$$

L63 : Luminance on the white raster (gray scale level L63)

L0 : Luminance on the black raster (gray scale level L0)

(3) Viewing Angle

Viewing angle is defined as the angles(θ , ϕ), in which specified contrast ratio can be obtained.
(Refer to 11.1(3) for the axes.)

(4) Luminance Uniformity:

The Luminance should be measured at 9 positions on white raster(gray scale level L63).

Uniformity can be calculated by the following expression.

$$\text{Luminance Uniformity} = \frac{\text{Minimum Luminance}}{\text{Maximum Luminance}} \times 100\%$$

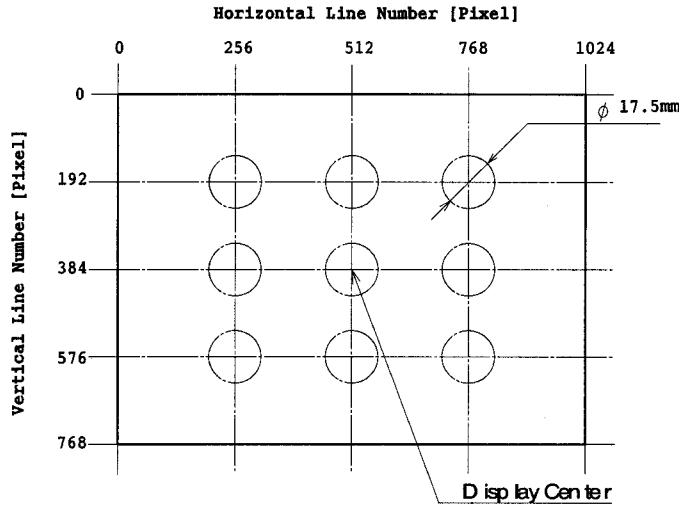

(5) Chromaticity :

The values(x,y) of chromaticity coordinates should be measured for the White, Red, Green and Blue Raster(gray scale level L63) each with a photometer.

(6) Response Time :

The response time (t_{ON} , t_{OFF}) is measured with a photo detector (photodiode) which measures the light intensity of the pixels.

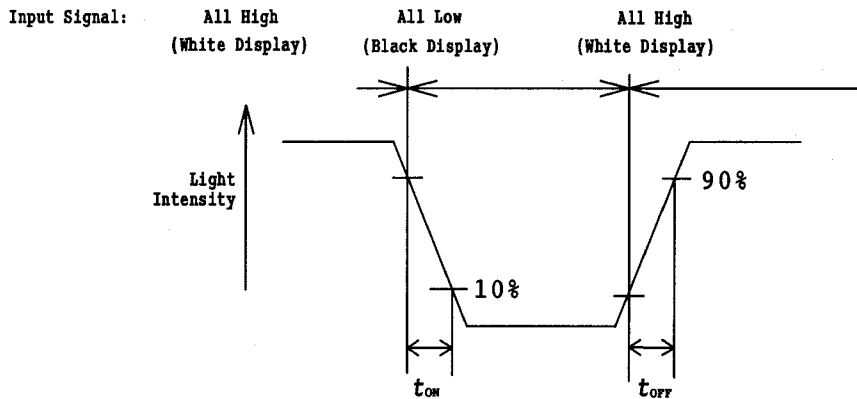

t_{ON} : Turn on time is the time for a photo detector output waveform to go from maximum value to 10% of its maximum.

t_{OFF} : Turn off time is the time for a photo detector output waveform to go from zero to 90% of its maximum.

- Photodiode : S1223-01 HAMAMATSU PHOTONICS K.K.
- White Display : White Raster (gray scale level L63)
- Black Display : Black Raster (gray scale level L0)